

# Excavator Mounted Vibrators (EMVs)



## Important Notes

All excavation work must be thoroughly planned before work commences on site to identify hazards and assess risk.

These instructions form guidance for Excavator Mounted Vibrators. Non-standard applications should be approved by a suitably qualified engineer.

Ensure all personnel engaged in piling operations are properly briefed and adequately supervised by a competent person.

**THIS USER GUIDE IS NOT CONTROLLED WHEN PRINTED**

To ensure you are reading the most up-to-date version of this user guide, [download as a pdf](#) from the Groundforce Technical Library.



A video showing a selection of piling equipment is available to [watch now](#) on our YouTube channel.

**IF IN ANY DOUBT SEEK FURTHER ADVICE:  
ON FREEPHONE - 0800 731 4960**



Certification Number 14419  
ISO 9001 • ISO14001 • ISO45001

Rev	Date	Comments	Initial
1.9	27/11/23	428M removed	DSW





Groundforce, Central House,  
Beckwith Knowle, Otley Road,  
Harrogate, HG3 1UD



T: 0800 000 345  
E: [info@vpgroundforce.com](mailto:info@vpgroundforce.com)

## SAFETY

### Common Symbols and Meanings

**Safety Note:** It is recommended that hand and eye protection are used when operating hydraulic equipment.

PERSONAL PROTECTIVE EQUIPMENT (PPE)	
	Use eye protection
	Use hearing protection
	Wear protective gloves
	Wear head protection
	Wear protective footwear

WARNING SYMBOLS	
	General warning
	Crushing of hands
	Hot surface or oil

## Introduction

Excavator Mounted Vibrators (EMVs) are specifically designed as pile driving and extracting attachments for excavators. They have a high power to weight ratio due to the high operating frequency and their ability to apply an additional vertical force from the excavator if required to assist driving. EMVs used in cohesive, granular soil conditions can significantly decrease driving time, reduce noise and minimise potentially hazardous vibrations.

EMVs can be attached to the excavator in two ways; either via a bracket directly to the dipper arm and connected to the excavator's hydraulic system, or via a Piletec VibroSafe Adaptor, if compatible. This exclusive design is a quick hitch adaptor which can be used with a fully automatic quick hitch coupler.

EMVs are of a slim design for ease of driving between adjacent upstanding piles. If required, the clamp can be removed and refitted at 90 degrees enabling piling at close range to an existing structure. For special applications the vibrator can be operated from a power pack.



**Safety Note:** Under no circumstances should an EMV with a standard single pin be attached to a quick hitch. Only fit to a quick hitch via a suitable Adaptor.



## Equipment Identification

### VibroSafe Adaptor

**Note:** adaptor and vibrator are colour coded yellow: they must be connected and disconnected in this position

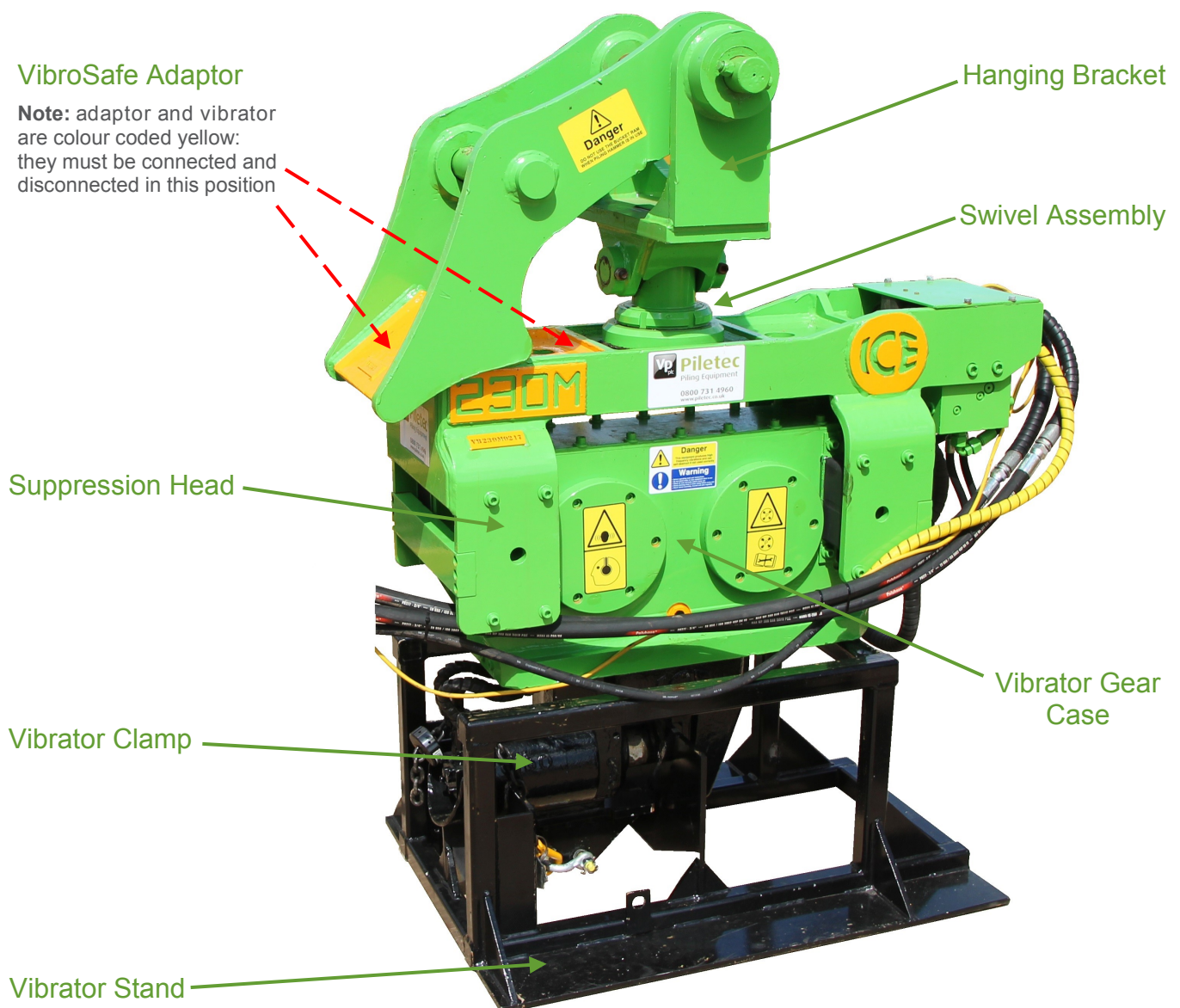

## EMV Model Specifications

MODEL	230M	230B	328M	328B <sup>#</sup>	428B	E5FM	625B	E7FM	823B	1223B
<b>Vibrator Specs</b>										
Eccentric moment - kgm	2.2	2.2	3.2	3.2	4.0	4.6	6	6.6	8	11.5
Max. centrifugal force - kN	220	220	275	275	345	395	410	452	464	670
Max. frequency - rpm	3000	3000	2800	2800	2800	2800	2500	2500	2300	2300
Max. amplitude - mm	7	6	9.5	8.5	9	14	13	16	19.1	16.4
Max. static line pull - kN	100	100	100	100	120	120	120	120	120	180
<b>Weights (kg)</b>										
EMV, Stand and Bracket	1150	1300	1170	1300	1480	1495	1570	1515	1590	2710
EMV, Stand, Bracket & VibroSafe model (R)*	R4 - 1270 R6 - 1290	R4 - 1420 R6 - 1440	R4 - 1290 R6 - 1310	R4 - 1420 R6 - 1440	R6 - 1620 R8 - 1660	R6 - 1635 R8 - 1675	R6 - 1710 R8 - 1750	R6 - 1655 R8 - 1695	R6 - 1730 R8 - 1770	R8 - 2890
<b>Dimensions (mm)</b>										
A - Height (with Bracket & VibroSafe)	1460	1685	1460	1685	1753	1774	1753	1744	1867	2250
B - Width	575	530	575	530	612	716	612	716	612	435
C - Length	1230	1115	1230	1115	1115	1380	1115	1380	1003	1540
D - Width at throat	258	258	258	258	300	344	300	344	385	310
<b>Power Pack</b>	ICE 100	ICE 100	ICE 100	ICE 100	ICE 180RF	N/A	N/A	N/A	N/A	N/A

\*R values refer to the size of VibroSafe adaptor being used

<sup>#</sup>The 328B can also be used as a Free Suspended Vibrator (FSV). See the FSV user guide for details.

MODEL	MS1 HFB	MS3 HFB	MS4 HFB
<b>Vibrator</b>			
Weight - EMV, Stand and Bracket (kg)	425	1090	1460
Weight - EMV, Stand, Bracket & VibroSafe model (R)*	N/A	R4 - 1210 R6 - 1230	R6 - 1600 R8 - 1640
Max. centrifugal force - kN	90	296	374
Eccentric moment - kgm	0.7	3	4.2
Max. oil flow - l/min	102	120	171
Max. working pressure - bar	300	300	300
Height (with Bracket & VibroSafe)	1061	1389	1614
B - Width	472	626	742
C - Length	835	1153	1239
D - Width at throat	230	260	340

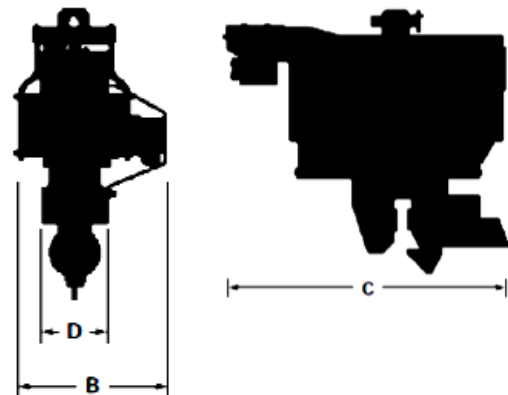

MODEL	EMV300
<b>Vibrator</b>	
Static moment - kgm	4.6
Frequency - rpm	2400
Centrifugal force - kN	300
Amplitude - mm	14.7
Max. oil flow - l/min	250
Min. oil flow - l/min	130
Max. working pressure - bar	350
Min. hydraulic power - kW	60
Max. push/pull force - kg	15000
Clamp force - tonne	36
Excavator class - tonne	12 - 35
Transport weight - kg	1220

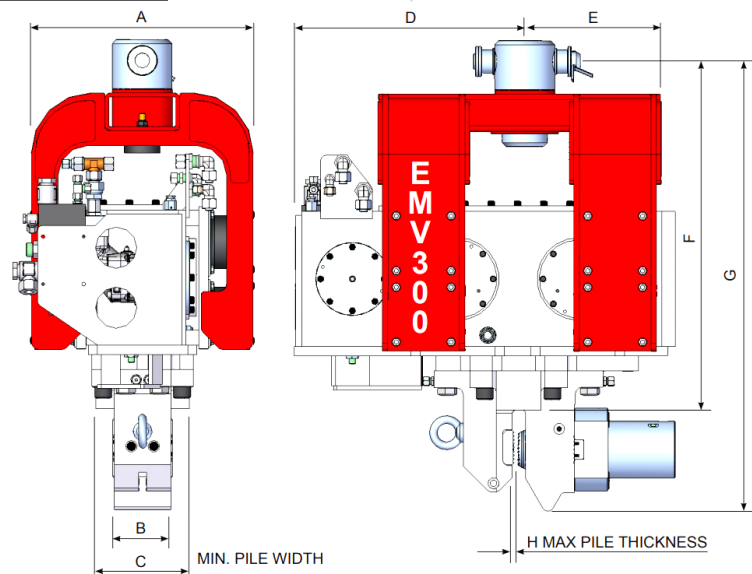

EMV300 Dim's (mm)	A	B	C	D	E	F	G	H
	615	150	250	582	429	927	1200	25

## Excavator Connection

**Note:** The **EMV300** is supplied with a hitch adaptor specific to that model, however the mounting procedure remains similar to that when using the VibroSafe Quick Hitch Adaptor.

There are two possible ways of connecting the Vibrator to the Excavator:

- Direct mount to the Dipper Arm
- Via the Piletec “VibroSafe” Quick Hitch Adaptor, or other suitable adaptor (best option)

### Direct Mount to the Dipper Arm via standard hanging bracket with single pin

1. Remove the quick hitch if fitted and connect the EMV direct to the dipper arm.
2. Connect the hoses to the bucket ram supply or dual flow breaker circuit if oil flow is sufficient.
3. Connect the pendent cable to 24v battery supply, ensuring in line fuse is fitted to the positive terminal (ICE Vibrators Only)
4. All EMV and excavator hose connections can be colour coded to ensure correct connection and operation of the EMV if removed regularly.

**Note:** The EMV should only be fitted and tested by an authorised competent person.

## The Piletec ‘VibroSafe’ Quick Hitch Adaptor

The VibroSafe Quick Hitch Adaptor is the safest possible solution when working with Excavator Mounted Vibratory Piling Hammers (EMVs).

This exclusive design comprises a quick hitch adaptor which can be used with a fully automatic quick hitch coupler. The adaptors will fit 90% of quick hitches currently on the market, however there may be some anomalies with sizes and profiles that may affect compatibility. In some case it will not be possible to check full compatibility until the excavator connects to the adaptor after an attempt is made to fit and fully lock.

### Compatibility Check

The adaptor sizes below can be used to ascertain compatibility with the excavator’s quick hitch system. If necessary, check with the excavator supplier to confirm which adaptor is suitable. For the VibroSafe adaptor to function, the excavator must have a ‘dual flow circuit’. A ‘single flow breaker circuit’ is not suitable.

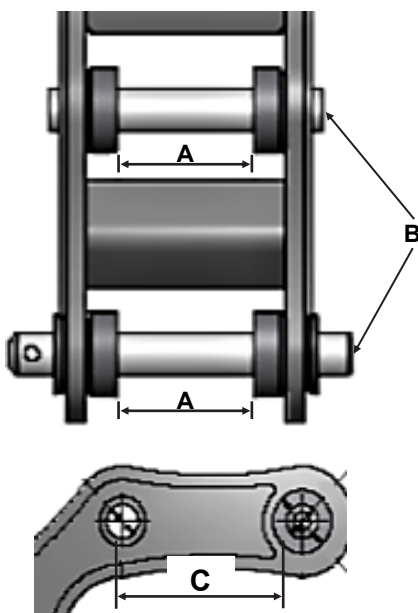

#### R4 Adaptor Sizes

A - Width between bushes = 285mm  
 B - Pin diameter = 65mm  
 C - Pin centres = 370mm  
 Weight = 120kg

#### R6 Adaptor Sizes

A - Width between bushes = 330mm  
 B - Pin diameter = 80mm  
 C - Pin centres = 443mm  
 Weight = 140kg

#### R8 Adaptor Sizes

A - Width between bushes = 410mm  
 B - Pin diameter = 90mm  
 C - Pin centres = 520mm  
 Weight = 180kg



**Note:** Do not operate the bucket ram whilst piling as this could result in serious damage and possible failure of the swivel assembly.





## Excavator connection via the 'VibroSafe' quick hitch adaptor



**Note:** Do not operate the bucket ram whilst piling: this could result in serious damage and possible failure of the swivel assembly



### Note on storage and transportation:

It is important to note that the EMV must be properly secured with straps when in storage or being transported. There must be two straps in use as below. The straps will be removed on delivery.



The EMV will arrive on-site secured with two straps as shown.



One strap secures the EMV to the stand.



A second strap secures the VibroSafe to the EMV.

**Safety Note:** The EMV **MUST** be stored or transported with **BOTH** straps fitted.



1. If not already done, remove the bucket from the quick hitch coupler as per the excavator manufacturer's instructions.



2. Position the dipper arm to ground level and shut down the excavator to prepare for hydraulic hose connection. Depressurise the hydraulic tank.



3. Attach the Quick Hitch Coupler to the VibroSafe adaptor. Fully curl/crowd the EMV and switch to the 'attach' or 'on' position: the buzzer will cease. Hold the crowd lever for approx 5-10 secs to allow the hook to fully engage/lock the VibroSafe pins.



4.

### Safety Note:

In addition to viewing from the excavator cab, the operator must align the cab and **identify a safe area** to perform a visual inspection to ensure the hook has fully engaged the piling head as circled red.



## Function Test

Once the EMV is connected, the following function test of the excavator's hydraulic and electrical systems will usually be undertaken by a qualified Piletec engineer:



**Safety Note:** Before starting the function test, ensure that the area is clear and personnel are at a safe distance in case of burst hoses or loose components



1. The EMV must be hanging free from the excavator and close to the ground for this test:

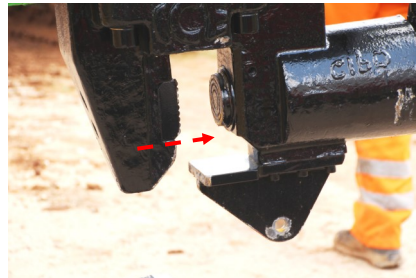

2. Open and close the clamp system at least ten times to ensure there are no restrictions of the return oil back to tank: ensure all relevant taps are open - this is very important for the motor case drain.

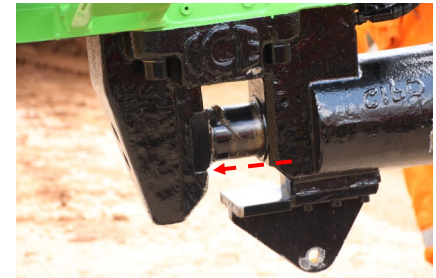

3. Run the vibrator at full speed to ensure the oil flow and vibrator speed are correct.

4. Re-check for full clamp operation: open the clamp and then start the vibrator, the clamp will start to close before the vibrator reaches full speed. This test confirms that the clamping system is being constantly topped up with oil when vibrating.

**If fitted with a pendent control cable, the following function test will apply:**

- The pendent has two buttons: one to open and one to close the clamp. Depending on the hydraulic connections, either button can be used.
- Send oil flow to the clamp system by pressing either button to confirm the button operation.

**Note:** If operating the 1223B model, there will be an additional button on the pendant control to operate the vibration function.

## Notes on using the Pitching Chain and Chain Clamp

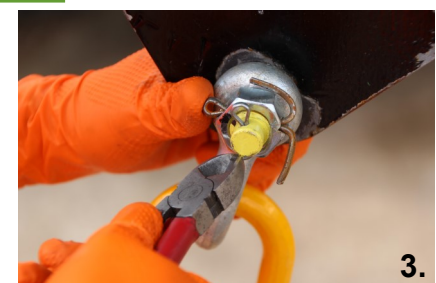
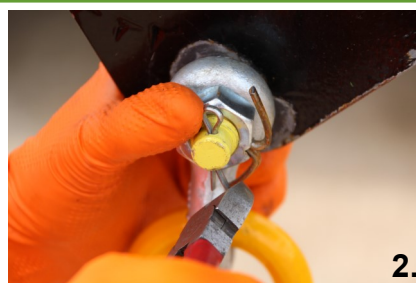

A certified pitching chain and chain clamp is connected to the pile guide on the EMV and is used to pitch piles for driving and stacking after extracting. The chain and shackle must be secured using two split pins as shown above.

**Note:** Do not continue until both split pins are correctly fitted and secured.

### Safety Notes:

Take extra care to avoid injury, including trapping of fingers during this procedure.

Operatives must be positioned clear of the excavator slewing zone.



4. Insert the Pitching Chain through the hole in the sheet pile, slide the chain clamp (inset) up the chain and lock into position.  
**Note:** Use the lowest hole where applicable.



5. Lower the vibrator on to the sheet pile, taking care not to damage the pitching chain.

## Notes on using the Pitching Chain and Chain Clamp Cont...

6. To close the clamp, move the bucket control lever/foot pedal to supply oil to the clamp, press the button (where applicable).
7. To vibrate, release the button (where applicable) and move the control lever/foot pedal to send oil to the vibrator. **Note:** the engine needs to be at optimum speed for the vibrator to run smoothly and effectively.
8. Start the vibrator and commence driving or extracting the sheet pile.
9. Return the lever/foot pedal to the neutral middle position to stop the vibrator. **Note:** before opening the clamp, make sure it is safe to do so: the pile should always be supported or on the ground before releasing the clamp.
10. Send oil to the clamp system to open the clamp and press the button (where applicable).
11. Remove the pitching chain and chain clamp from the sheet pile when safe to do so.

## Vibrator Refusal Limits

For vibratory driving and extracting, Piletec recommends the following refusal limits are adhered to for health and safety reasons, efficient operation and to avoid equipment failure or destruction.

### Normal driving conditions definition

Normal driving conditions are defined when the penetration or extraction rate is approximately 5 minutes per metre.

### Refusal limit definition

The refusal limit is defined when the penetration or extraction rate is greater than 5 minutes per 250mm.

In this occurrence, do not continue. Continuing to use the equipment at the refusal limit means considerable damage may occur which could result in charges for repairs.



**Safety Notes:** Failure to follow refusal rate guidelines may result in health and safety issues to site personnel and may cause irreparable damage or destruction of the equipment.



## Removal / Disconnection



1. Place the piling hammer onto the stand and close the clamp.



2. Disengage the Quick Hitch Coupler from the VibroSafe adaptor. curl/crowd the EMV and switch to the 'unlock' or 'disengage' position. Allow the hook to fully disengage/unclamp the VibroSafe pins.

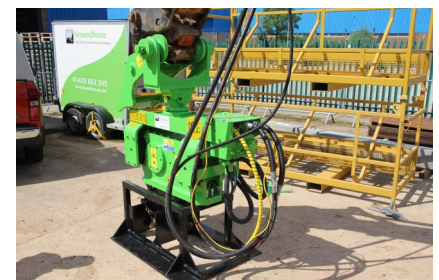

3. Ensure the hammer and stand are fully placed on the ground prior to removing the hitch from the piling hammer.



4. Place the dipper arm to ground level and shut down the excavator prior to disconnecting the hydraulic pipes. Depressurise the hydraulic tank.



5. As when delivered, the EMV **must** be properly secured with **two** straps when in storage or being transported.

### Safety Note:

The EMV **MUST** be stored or transported with **BOTH** straps fitted.



Do	Do Not
<ul style="list-style-type: none"> <li>✓ Ensure operator and piling crew are trained, familiar and competent</li> <li>✓ Only use certified pitching chain and chain clamp</li> <li>✓ Only use the pitching chain and chain clamp for pitching the sheets into place before driving or when extracting</li> <li>✓ Check the pitching chain and chain clamp before every use</li> <li>✓ Ensure the pitching chain and chain clamp are fitted correctly before every use</li> <li>✓ Always maintain a practical exclusion zone whilst piling is in progress</li> <li>✓ Only fit to a quick hitch via a VibroSafe Adaptor</li> <li>✓ Perform a visual inspection to check the quick hitch has fully locked the VibroSafe adaptor before every use</li> <li>✓ Ensure the EMV is on level ground</li> <li>✓ Check all nuts and bolts before every use</li> <li>✓ Check swivel assembly before every use</li> <li>✓ Check the rubber elastomers</li> <li>✓ Check the gear oil is half full on the sight glass daily: the EMV must be level for this check</li> <li>✓ Perform the function check on a daily basis</li> <li>✓ Take care to avoid trapping fingers at all times</li> </ul>	<ul style="list-style-type: none"> <li>✗ Use the pitching chain for snatching at the pile</li> <li>✗ Use an EMV with a single pin attached to a quick hitch</li> <li>✗ Carry a pile around in the EMV clamp, the oil pressure is not being topped up and the pile could fall</li> <li>✗ Place the Vibrator and stand on the floor to try and remove or test that the Quick Hitch has fully locked</li> <li>✗ Remove the auxiliary hoses when the quick hitch is attached to Vibrator</li> <li>✗ Operate the bucket ram when piling is in progress</li> <li>✗ Leave a pile suspended off the ground in the EMV clamp, always rest the pile on the floor and top up the clamp pressure before lifting</li> <li>✗ Stand under or near the vibrator whilst in operation</li> <li>✗ Continue to use the vibrator if the pile is not moving, contact Piletec for advice</li> <li>✗ Open clamp whilst the pile is suspended</li> <li>✗ Stand under the vibrator when piling is in progress</li> <li>✗ Apart from the checks outlined in this user guide, do not perform any user maintenance on the EMV</li> </ul>

## Excavator Mounted Vibrator (EMV) and Pre Auger Course

This safety critical course introduces the learner to the theoretical and practical dangers of Excavator Mounted Vibrators (EMVs) and Augers.

Upon completion of the course learners will be able to differentiate between the various types of piling activities, understand Piling and Auger hazards along with the implementation of specific controls measures to reduce risk. [Visit the course page](#) for more details.

**The half day course can accommodate up to 8 delegates per day.**

### EXCAVATION TRAINING AVAILABLE

Train your team with **Groundforce Training Services**

• Nationwide training locations • EUSR accredited • Flexible courses

☎ 0800 023 2663